

bopita®

ASSEMBLY INSTRUCTION
MONTAGE HANDLEIDING
MONTAGE ANLEITUNG
NOTICE DE MONTAGE
MANUAL DE MONTAJE

UK
NL
D
F
ESP

MODEL
TYPE
COLOUR
ART.CODE

: UNIVERSAL
: PROTECTION SIDE FOR SIDES 18 MM
: WHITE
: 196204.11.

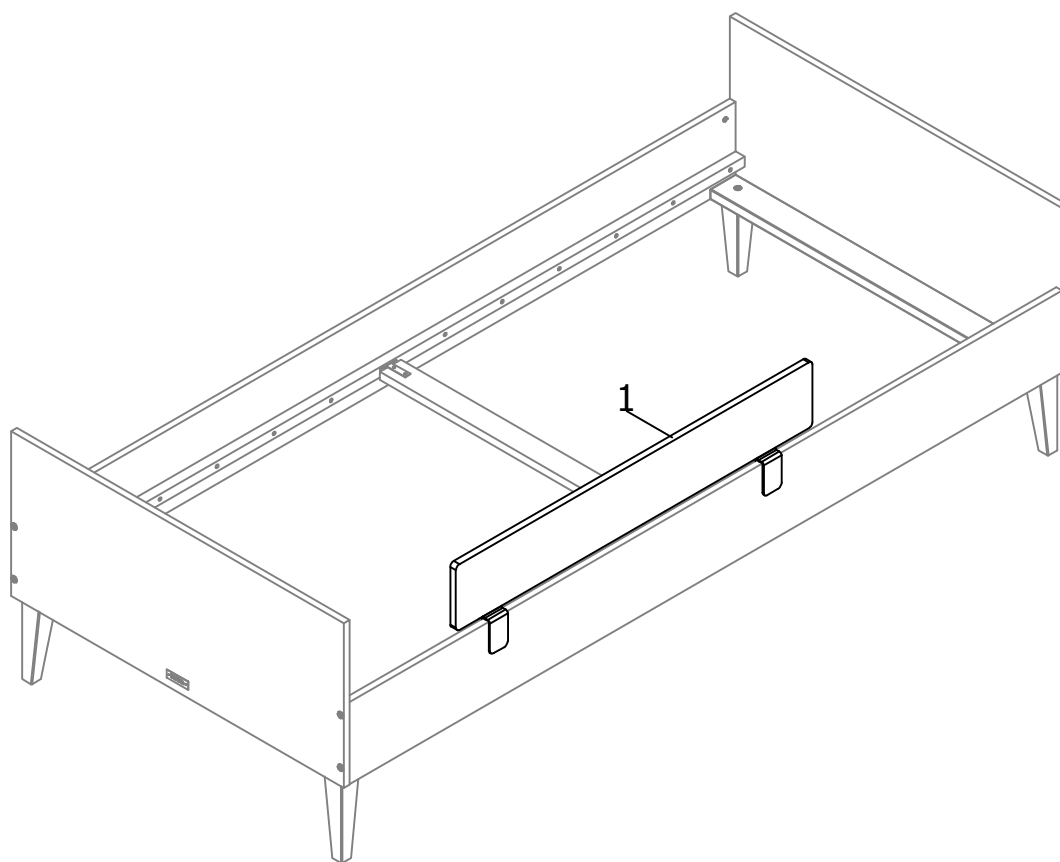



Distributor:

BOPITA
Energieweg 1
6662 NS Elst
The Netherlands

www.bopita.com



24.06.2020.

<p>A</p>  <p>M6X10 4X</p>	<p>B</p>  <p>M4X6 2X</p>	<p>C</p>  <p>2X</p>
---	--	---

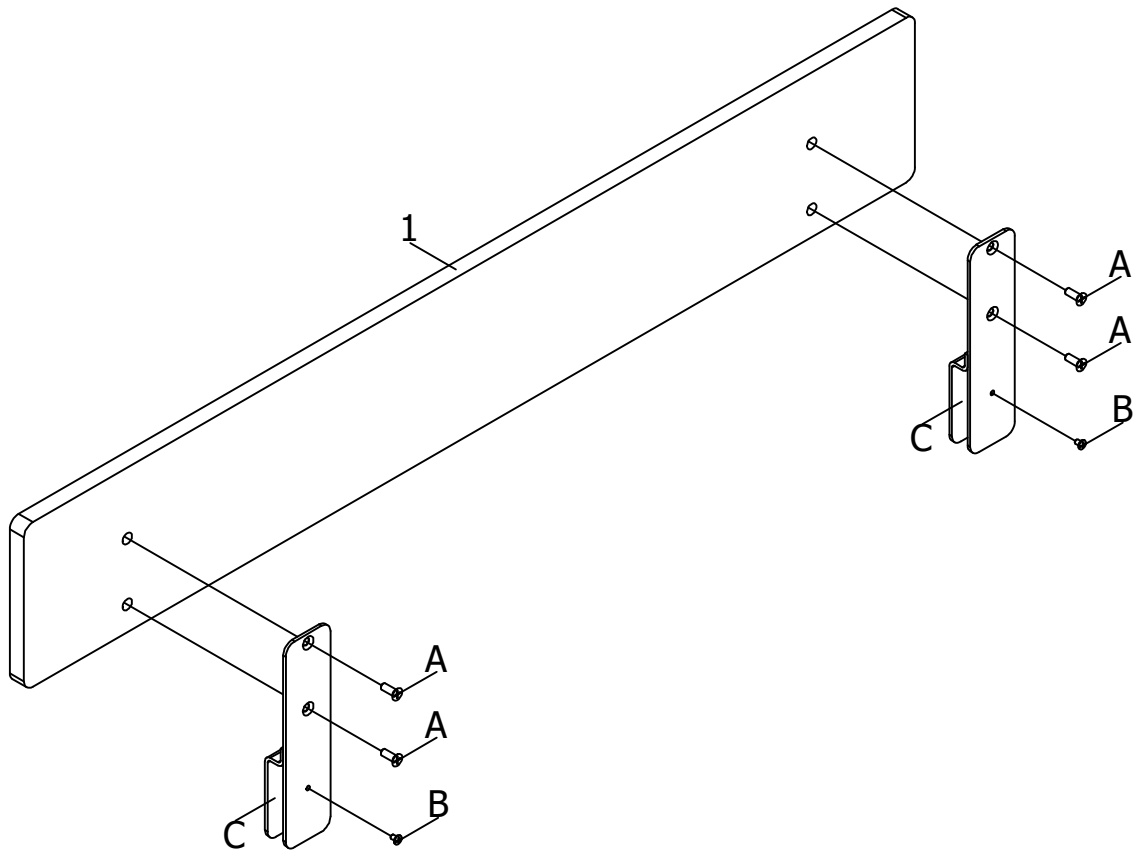

1

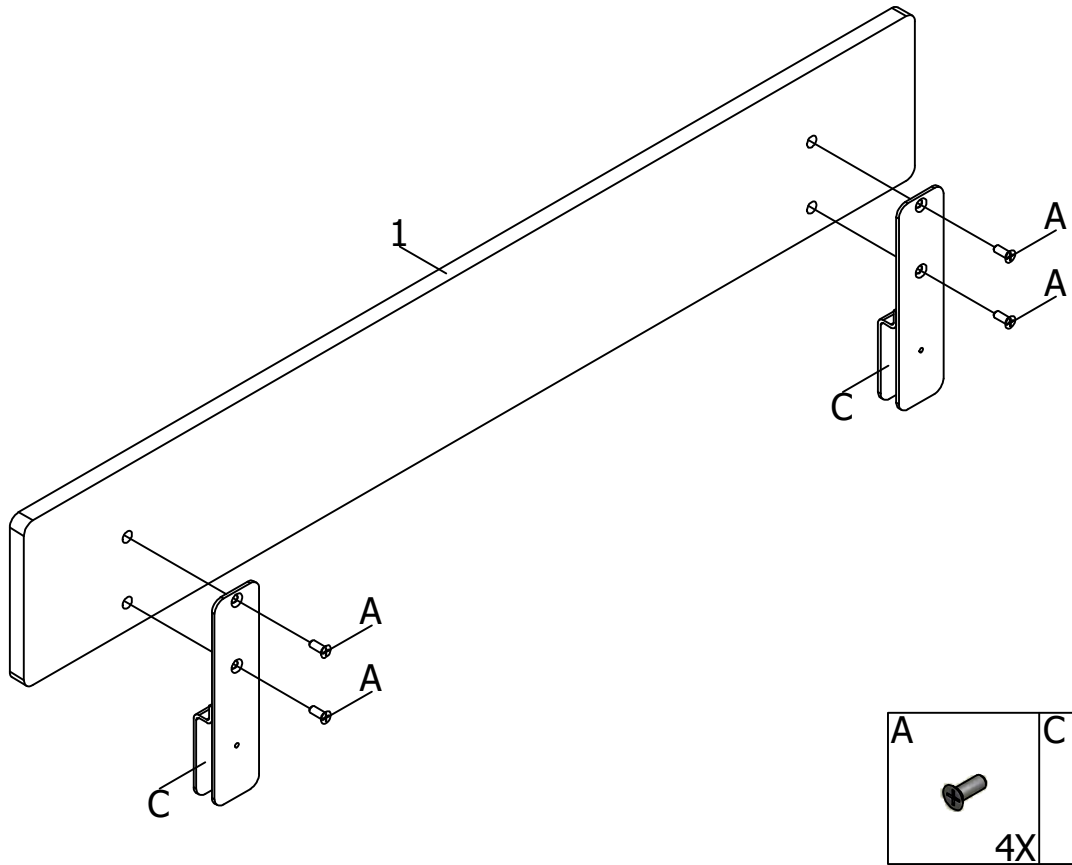

2

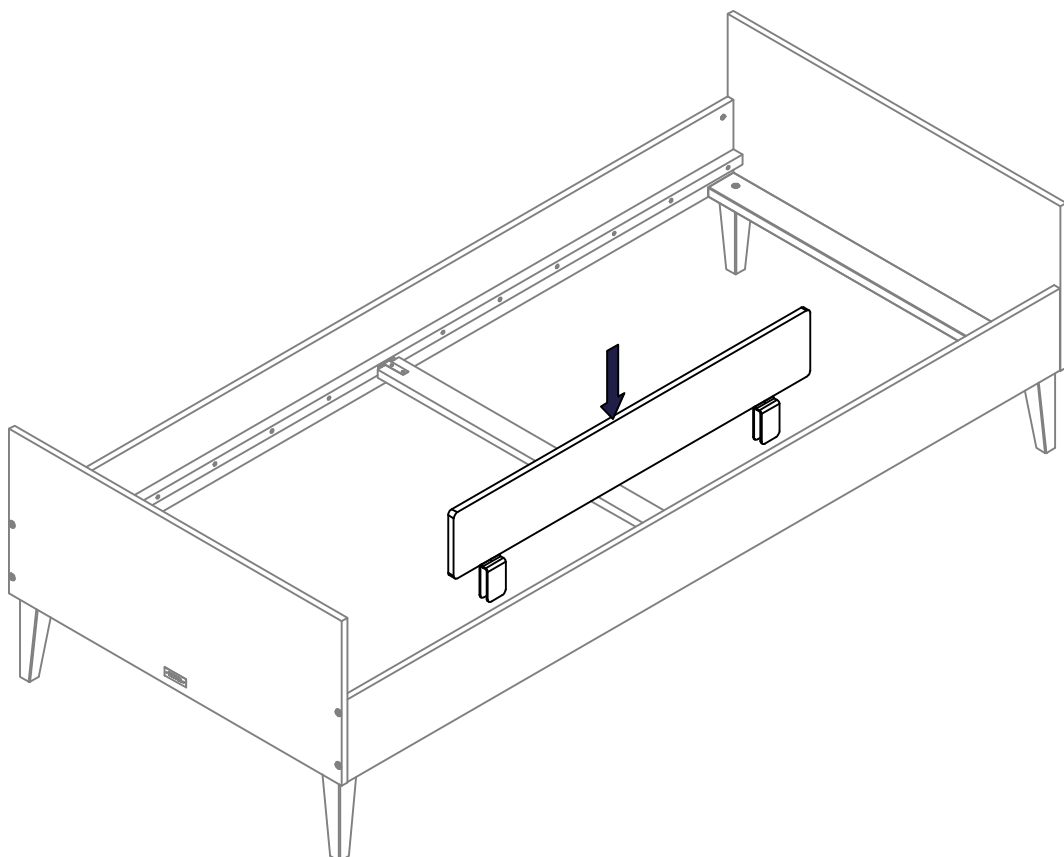

3

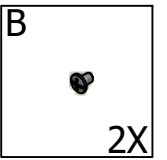
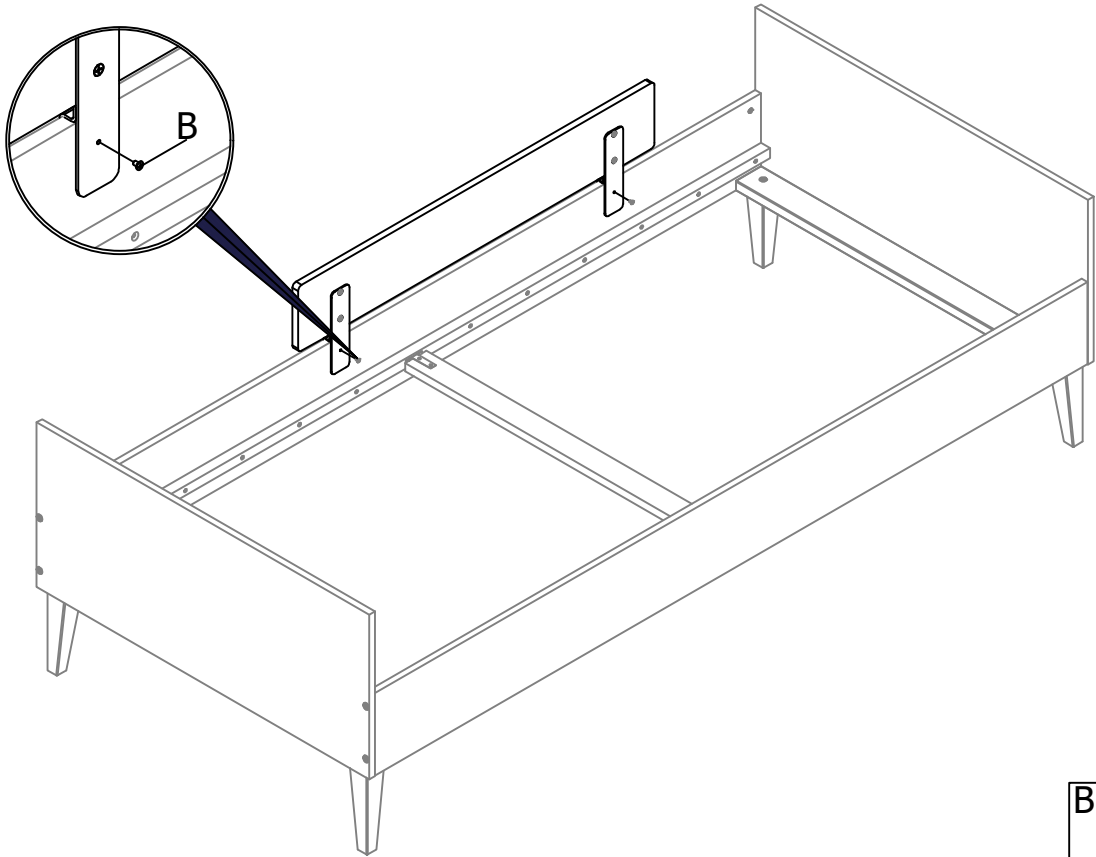

4

